

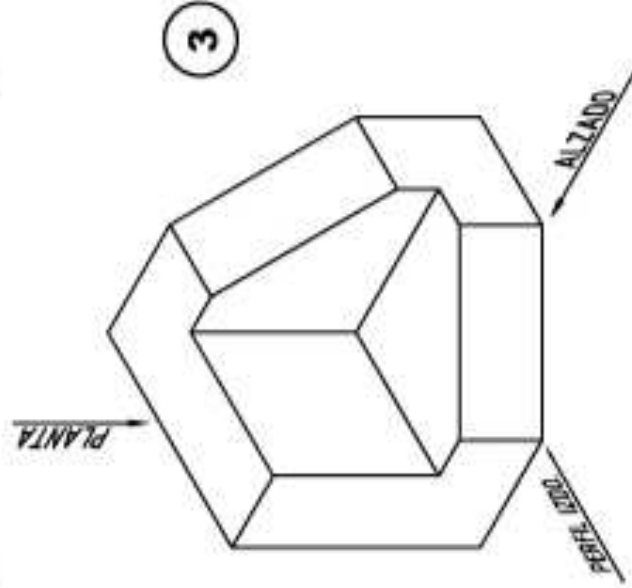

2. Dibuja las vistas de las piezas de la derecha.

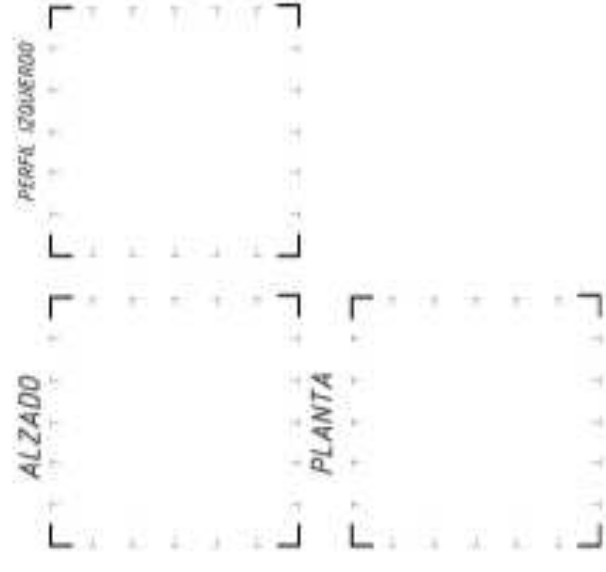

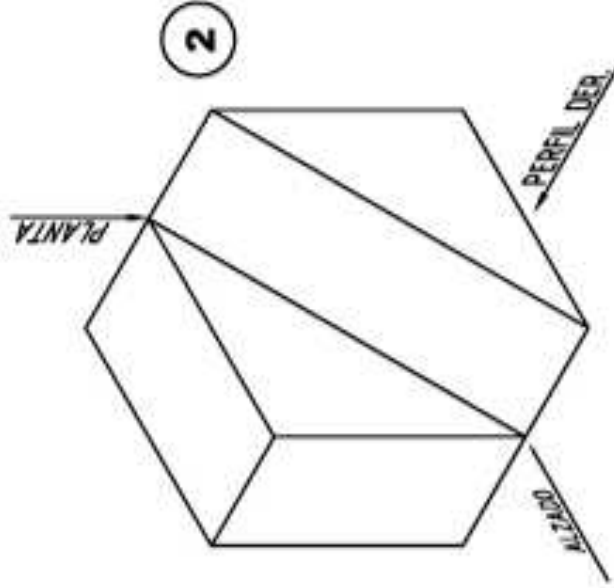

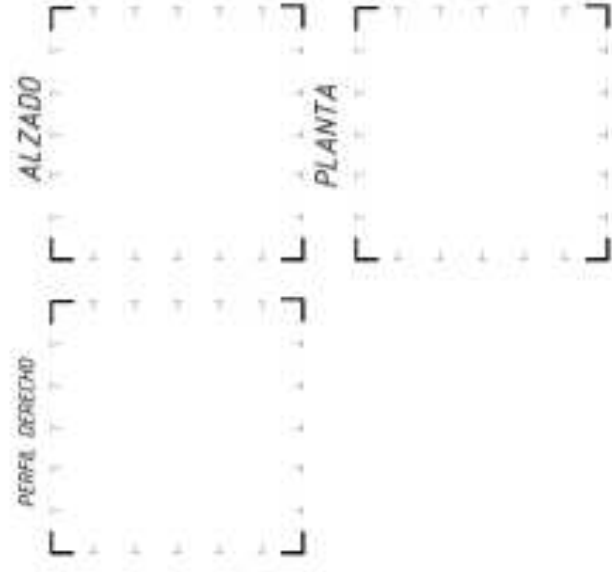
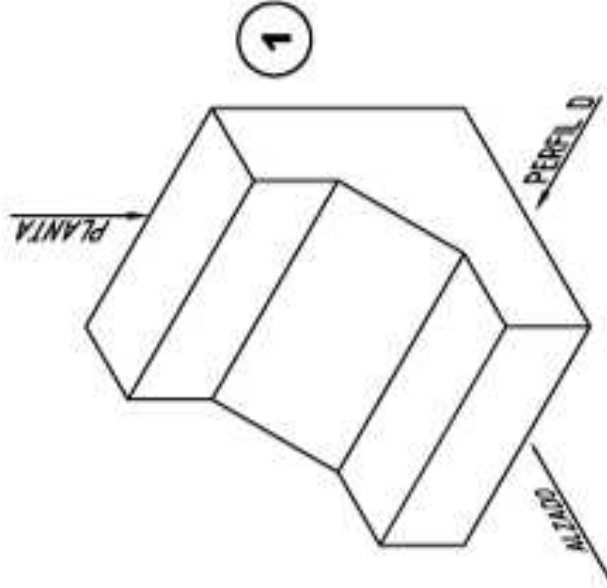
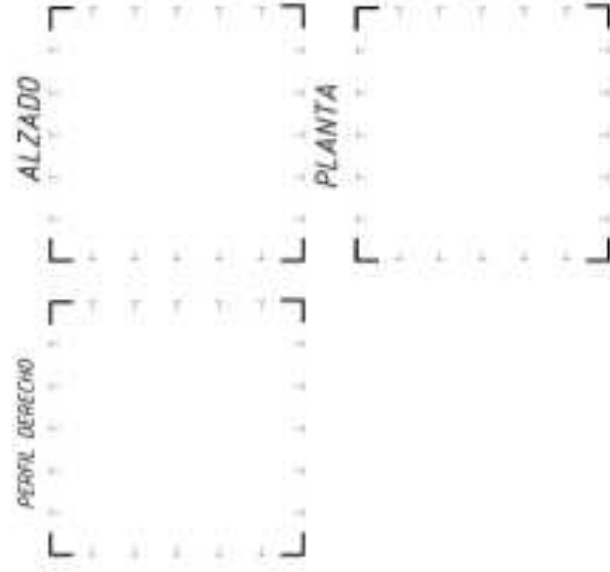
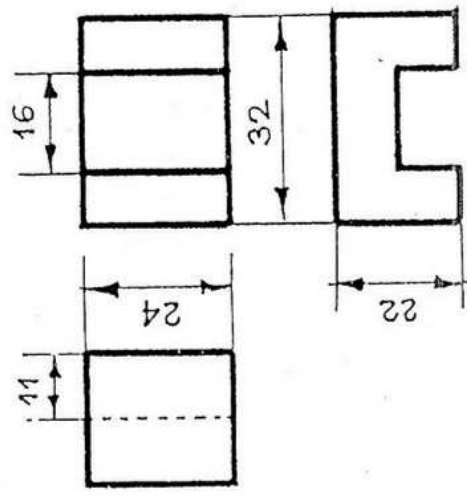
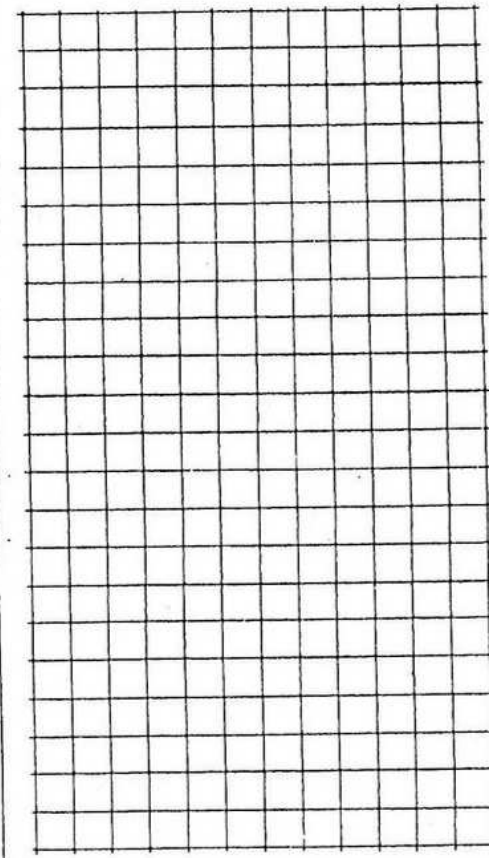
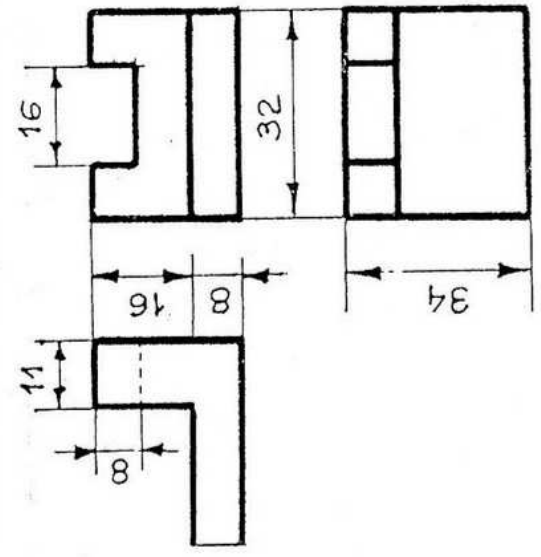
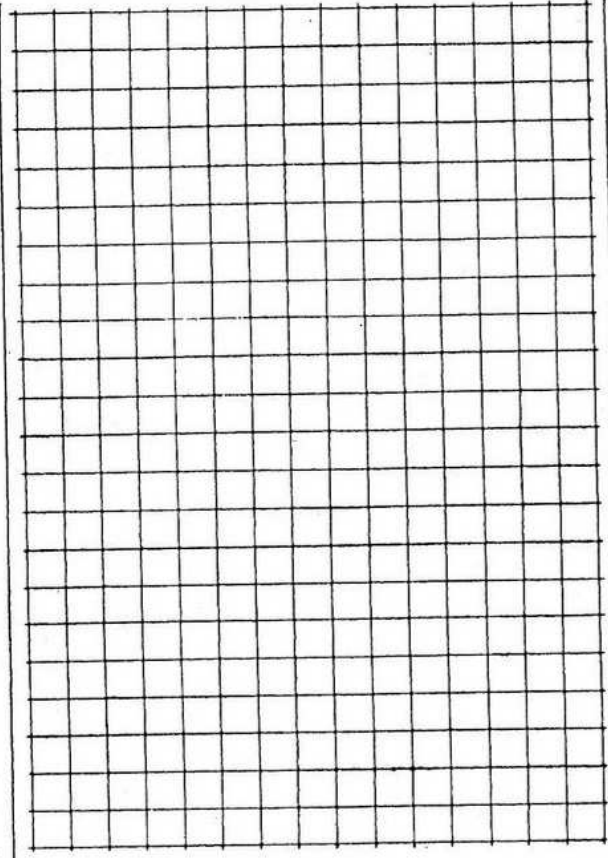
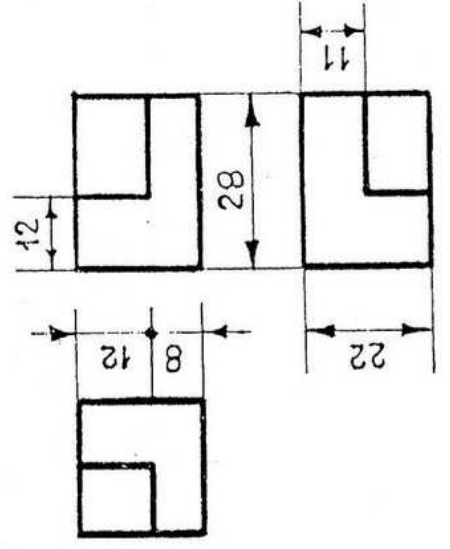
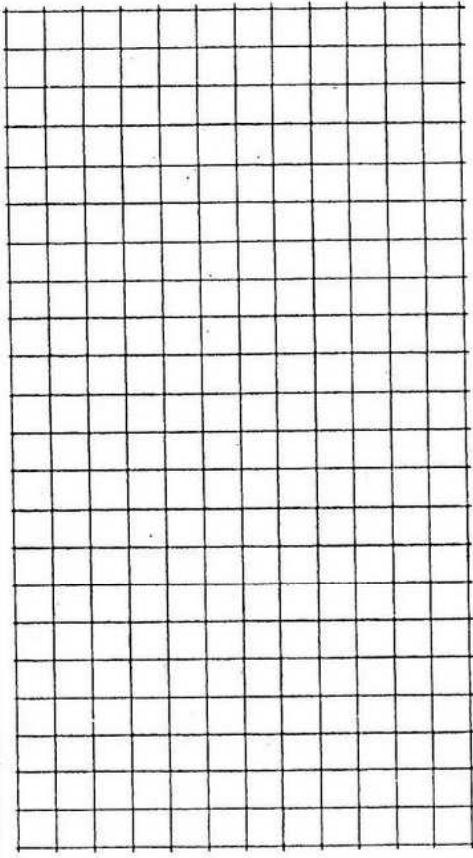
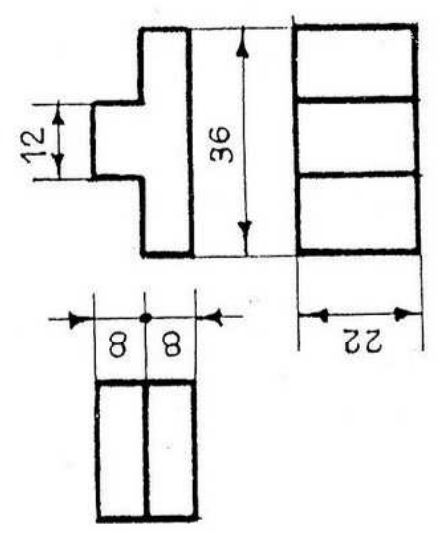
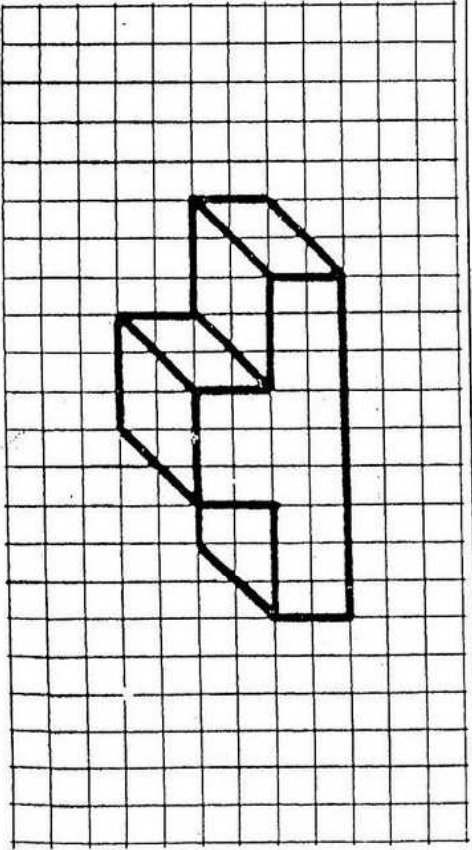
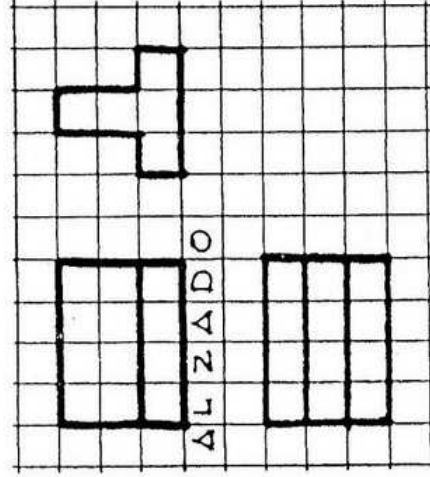
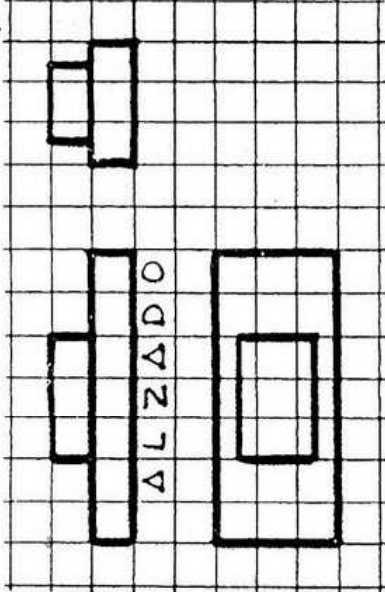
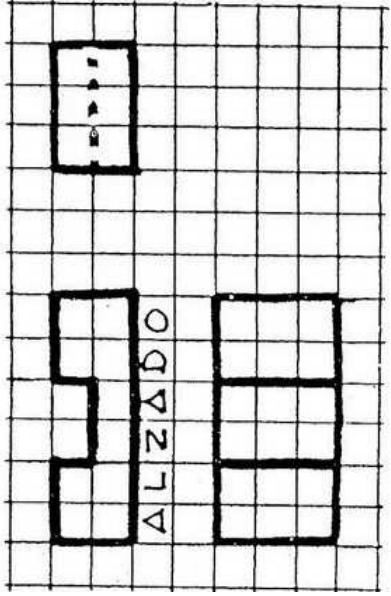
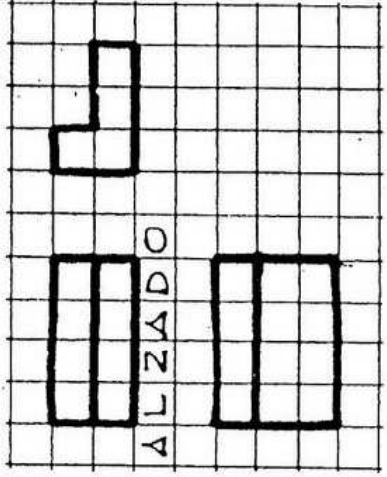
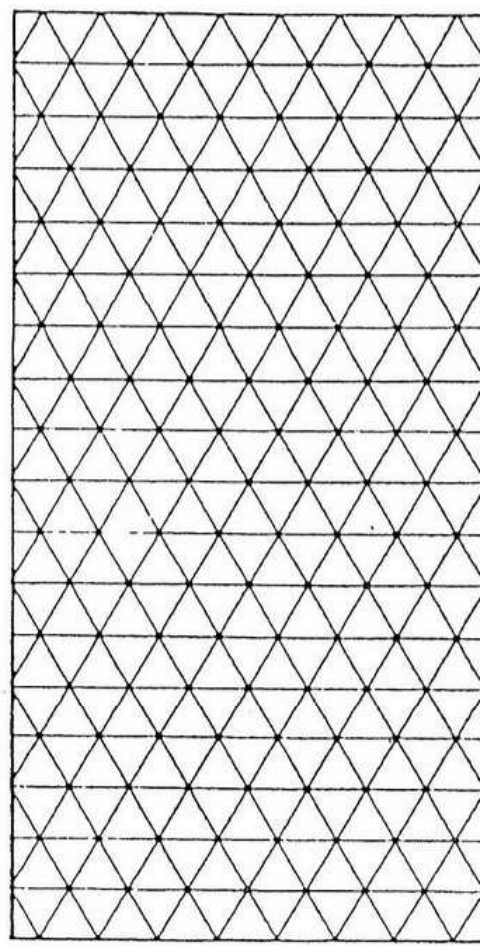
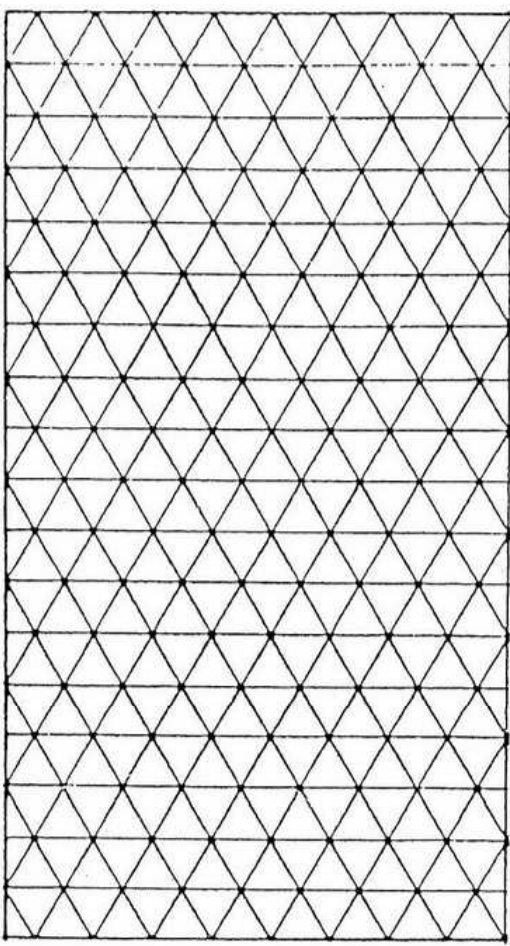
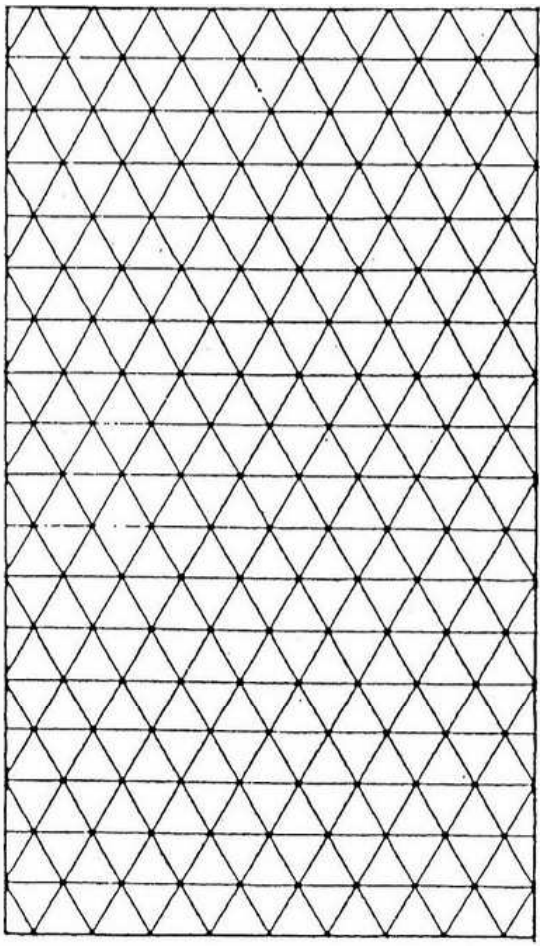
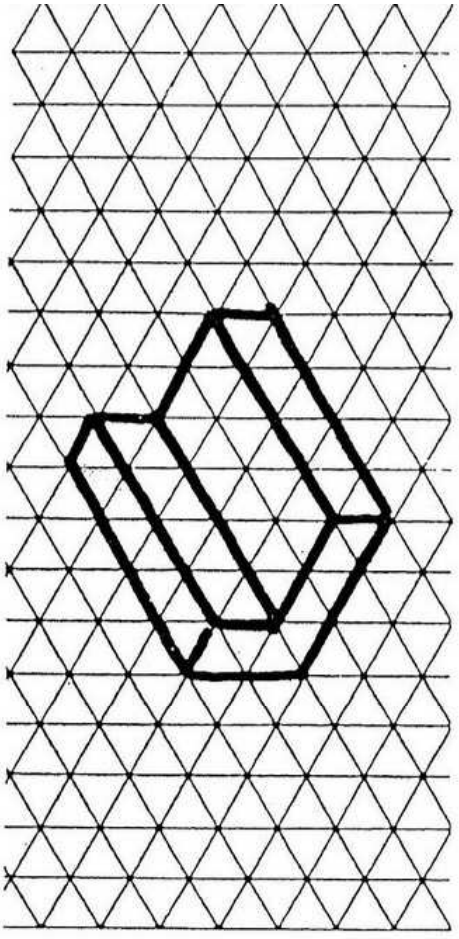

En el ejemplo A se ha realizado la perspectiva caballera de un cuerpo dado en tres vistas. Dibuja en B la perspectiva de la casa a mano alzada y proporcionadamente.

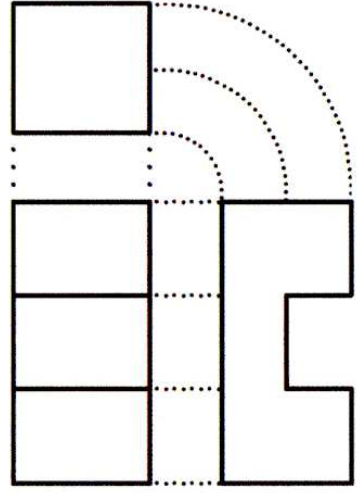
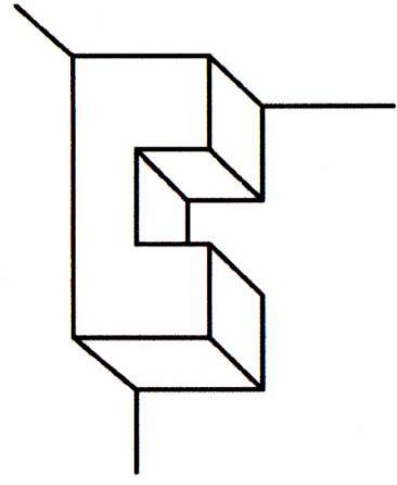

**A**

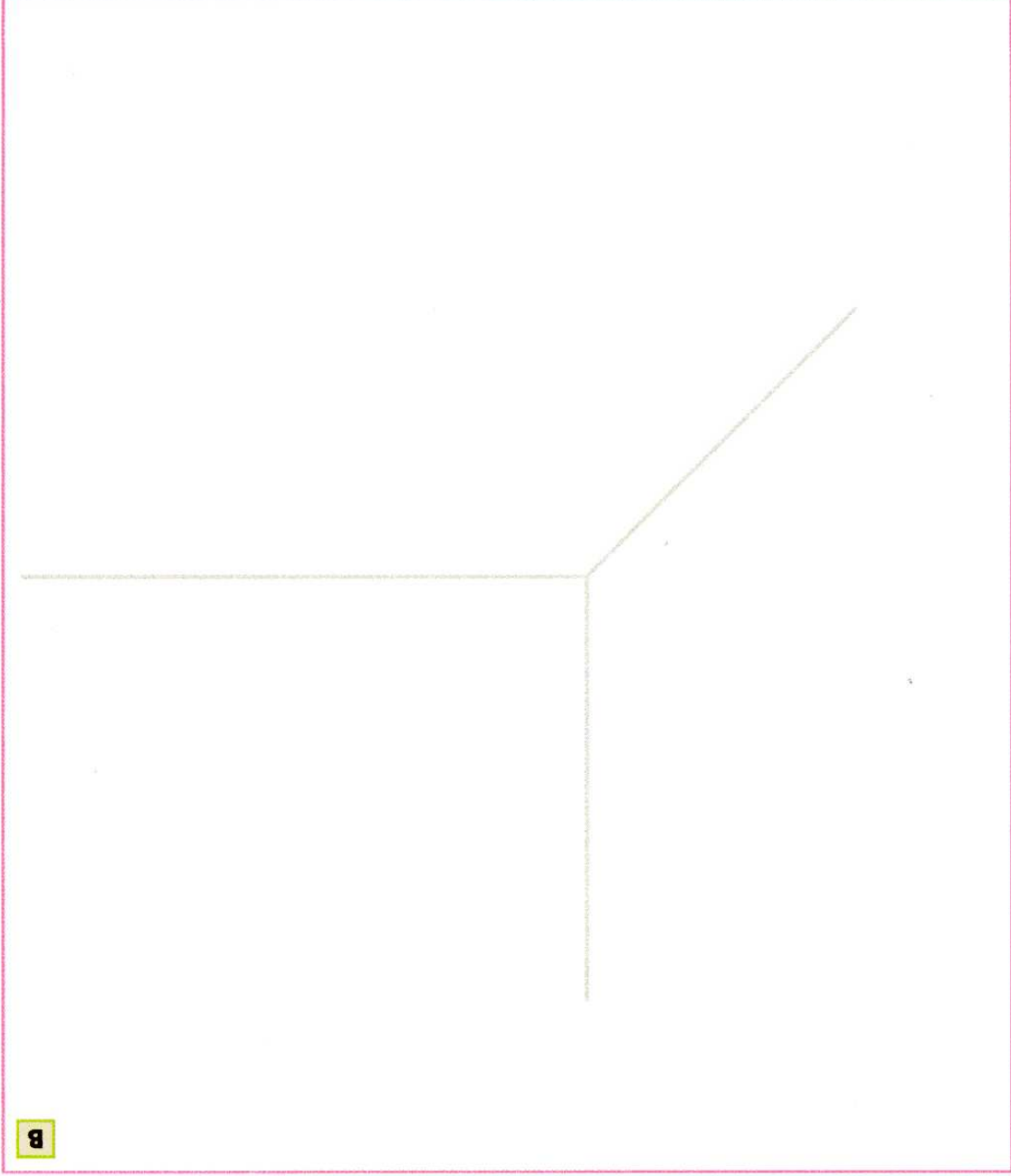
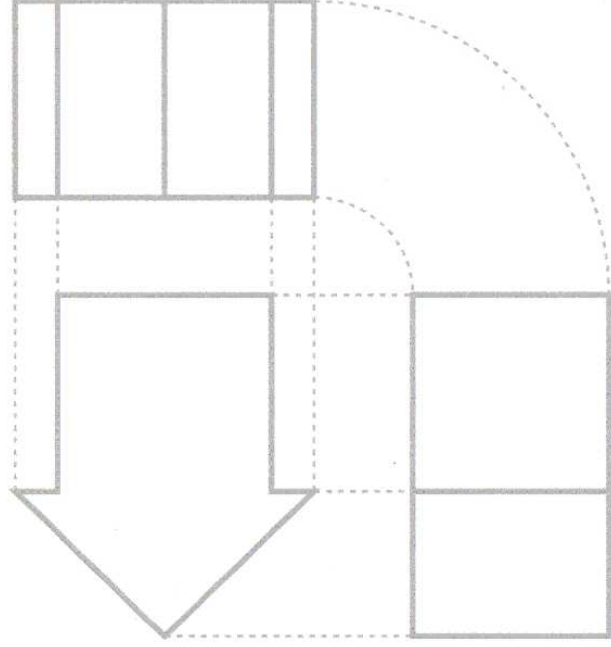

**B**

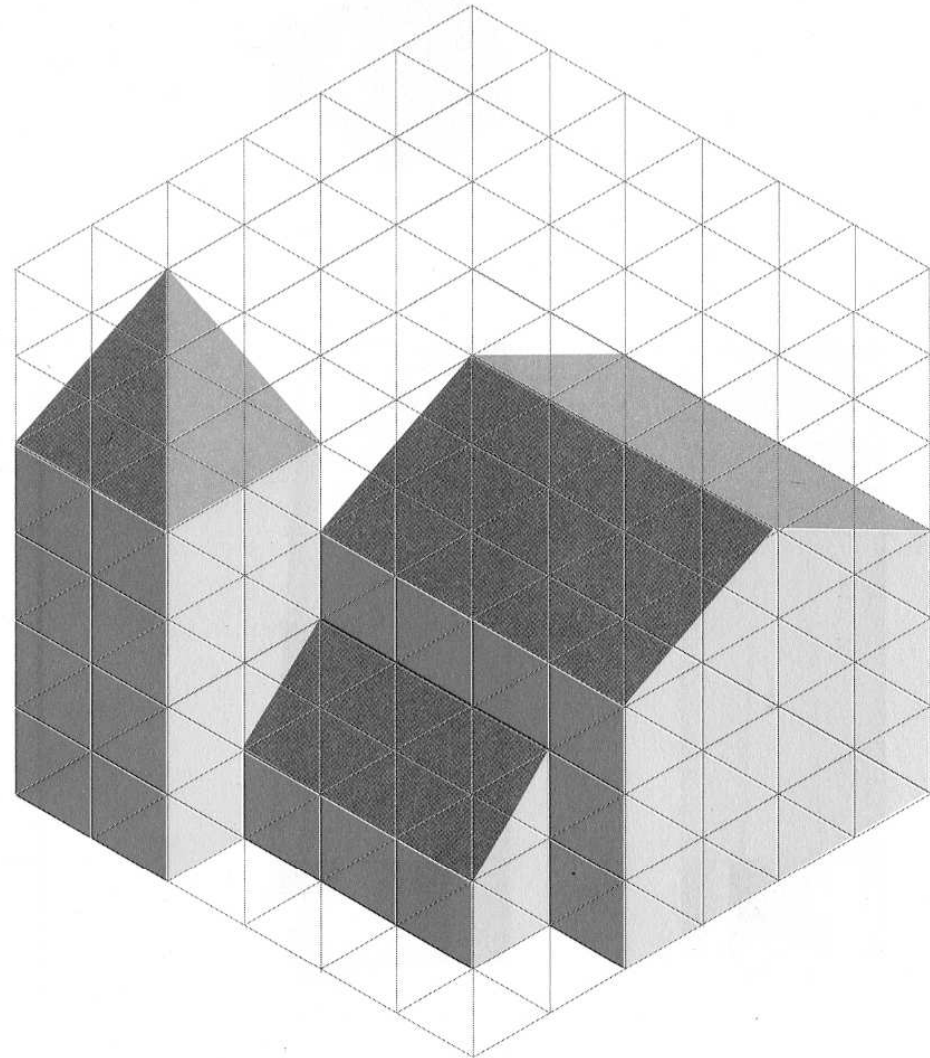
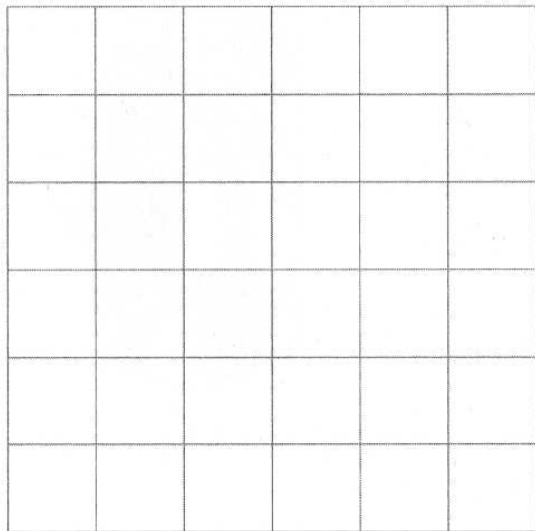
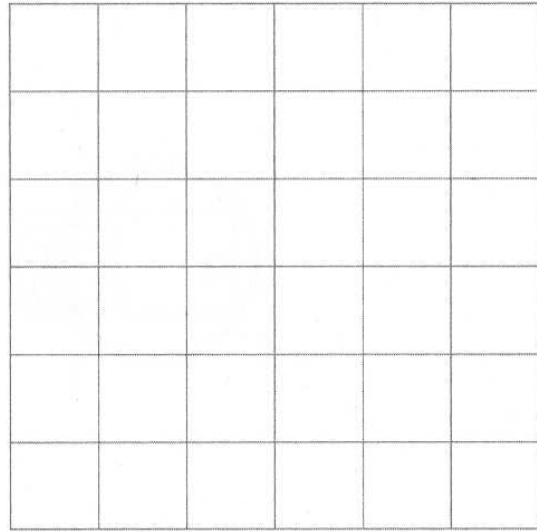
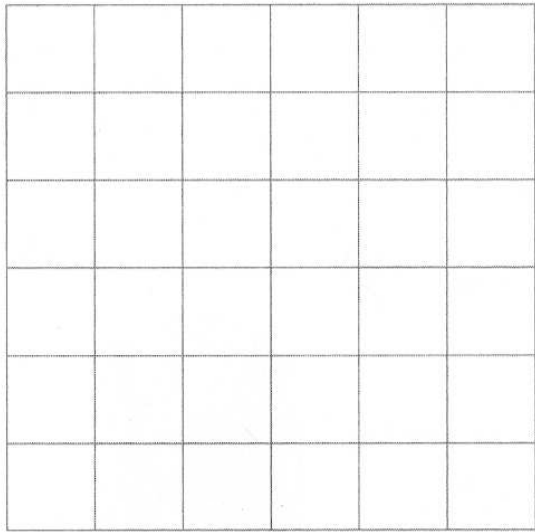

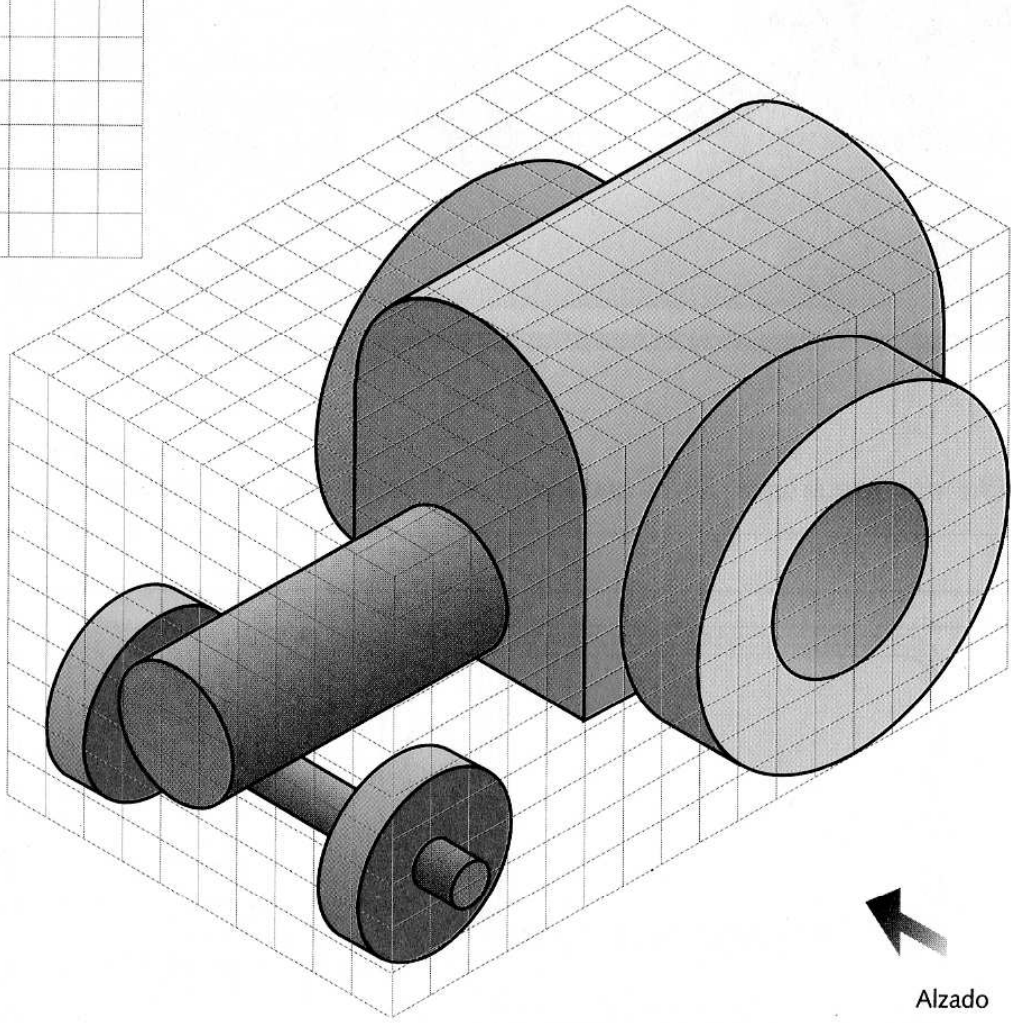
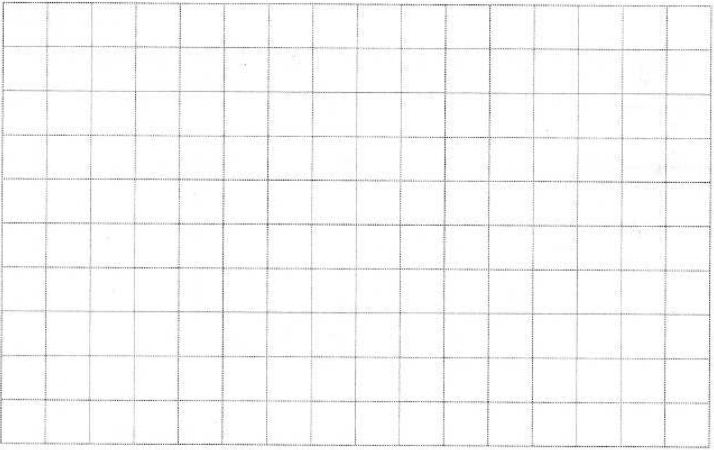
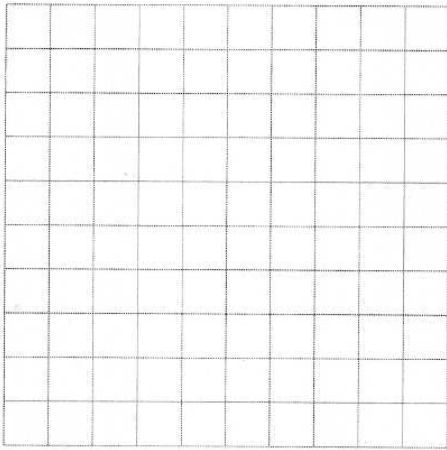
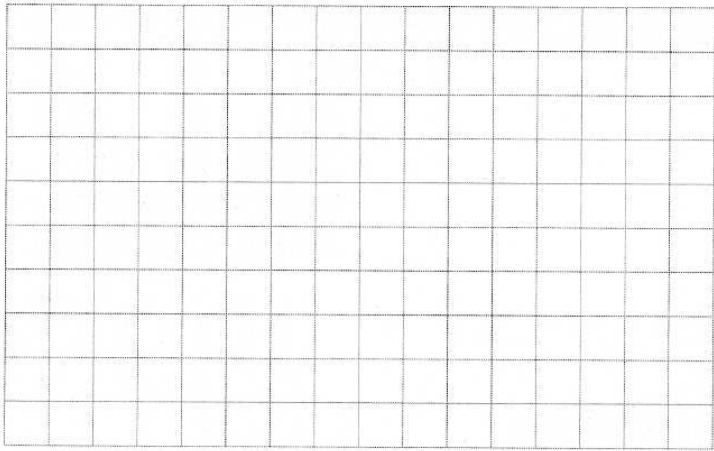

Alzado

Alzado

Perfil

Planta

Visualización de la planta

Visualización del perfil

Visualización del alzado

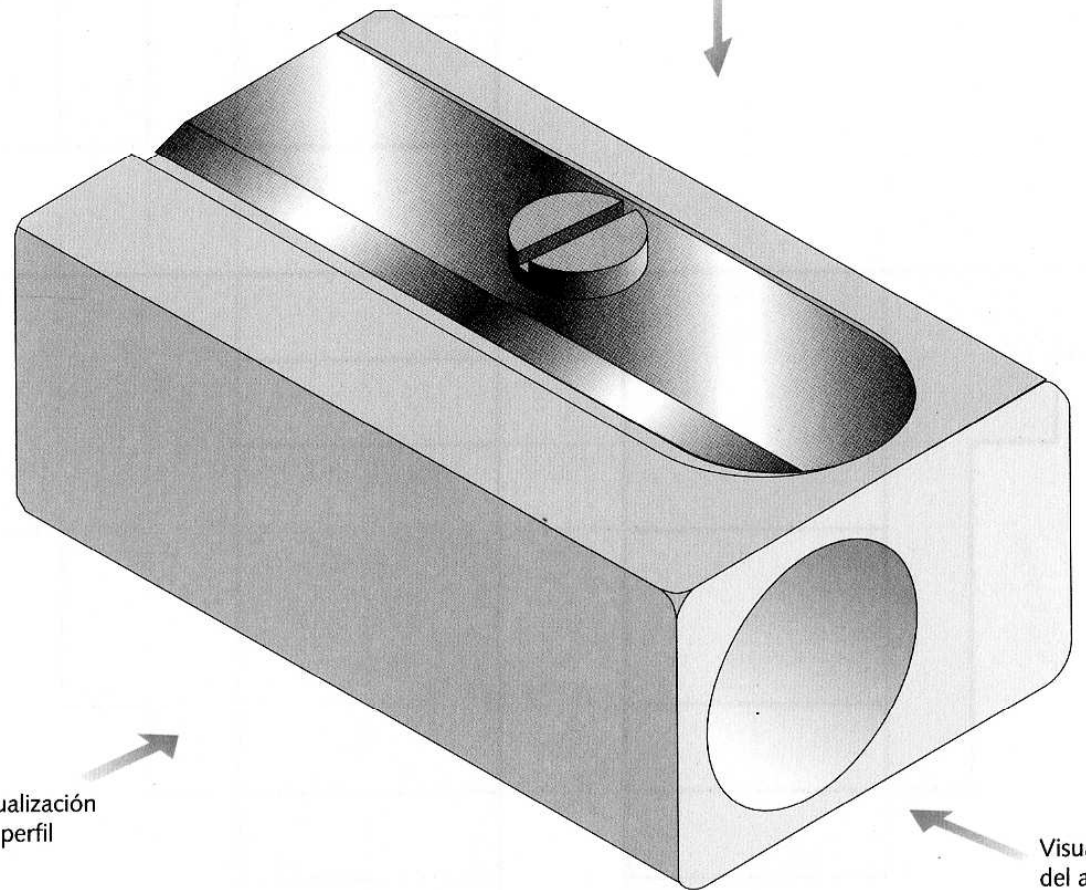

ROZASABOR

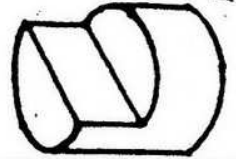
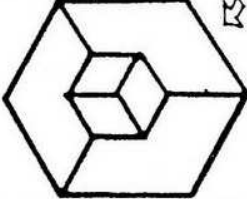
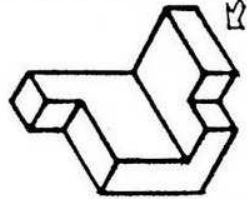
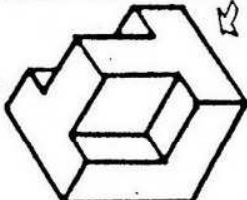
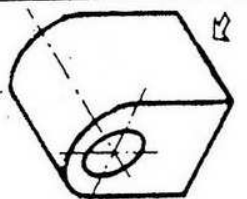
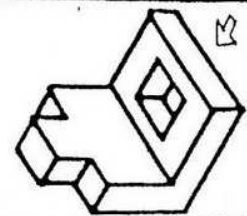
					
ALZADO					
PLANTA					
LATERAL IZDO					

Escribe en este cuadro los números de las vistas que le corresponden.

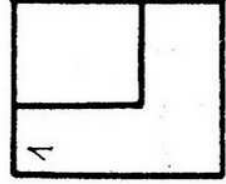
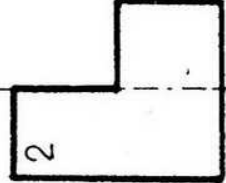
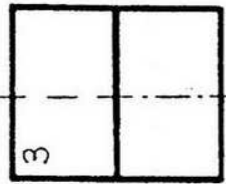
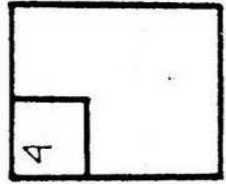
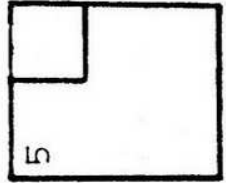
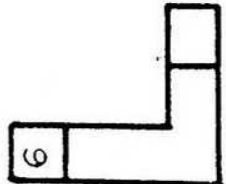
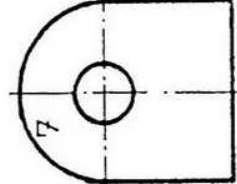
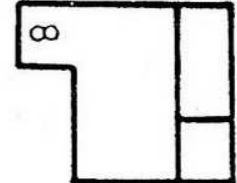
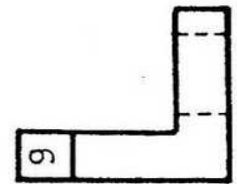
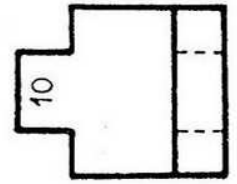
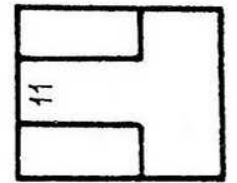
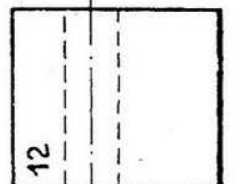
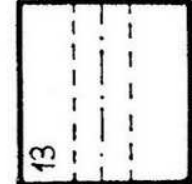
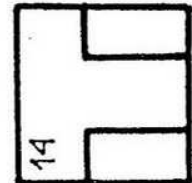
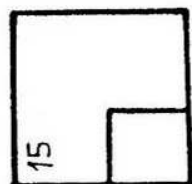
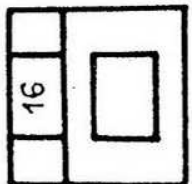
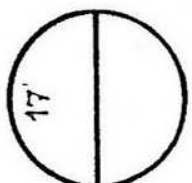
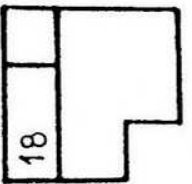



1. Dibuja las vistas de las piezas de la derecha de la perspectiva. Colorea cada cara de la perspectiva y su vista correspondiente con un mismo color.

